

General Purpose Transistors

NPN Silicon

- We declare that the material of product compliance with RoHS requirements.
- S- Prefix for Automotive and Other Applications Requiring Unique Site and Control Change Requirements; AEC-Q101 Qualified and PPAP Capable.
- **Ordering information**

Device	Marking	Shipping
2SC4617Q	BQ	3000 Tape & Reel
2SC4617R	BR	3000 Tape & Reel
2SC4617S	BS	3000 Tape & Reel

2SC4617 Series
S-2SC4617 Series

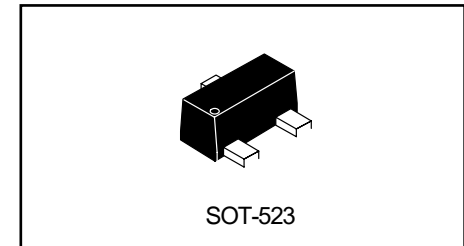

● Absolute maximum ratings (Ta=25°C)

Parameter	Symbol	Limits	Unit
Collector-base voltage	V _{CB0}	60	V
Collector-emitter voltage	V _{CEO}	50	V
Emitter-base voltage	V _{EBO}	7	V
Collector current	I _C	0.15	A
Total device dissipation, T _A = 25°C Derate above 25°C	P _D	0.15 1.2	W mW/°C
Thermal Resistance Junction-to-Ambient	R _{θJA}	833	°C/W
Junction temperature	T _j	150	°C
Storage temperature	T _{stg}	-55~+150	°C

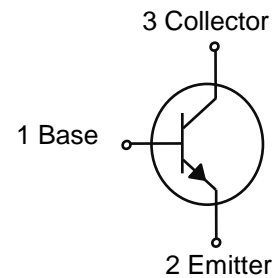

● Electrical characteristics (Ta=25°C)

Parameter	Symbol	Min.	Typ.	Max.	Unit	Conditions
Collector-base breakdown voltage	BV _{CB0}	60	-	-	V	I _C =50μA
Collector-emitter breakdown voltage	BV _{CEO}	50	-	-	V	I _C =1mA
Emitter-base breakdown voltage	BV _{EBO}	7	-	-	V	I _E =50μA
Collector cutoff current	I _{CB0}	-	-	0.1	μA	V _{CB} =60V
Emitter cutoff current	I _{EBO}	-	-	0.1	μA	V _{EB} =7V
Collector-emitter saturation voltage	V _{CE(sat)}	-	-	0.5	V	I _C /I _B =50mA/5mA
DC current transfer ratio	h _{FE}	120	-	560	-	V _{CE} =6V, I _C =1mA
Transition frequency	f _T	-	180	-	MHz	V _{CE} =12V, I _E =2mA, f=30MHz
Output capacitance	C _{ob}	-	2.0	3.5	pF	V _{CB} =12V, I _E =0A, f=1MHz

● h_{FE} values are classified as follows:

Item	Q	R	S
h _{FE}	120~270	180~390	270~560



ELECTRICAL CHARACTERISTIC CURVES
(Ta = 25°C)

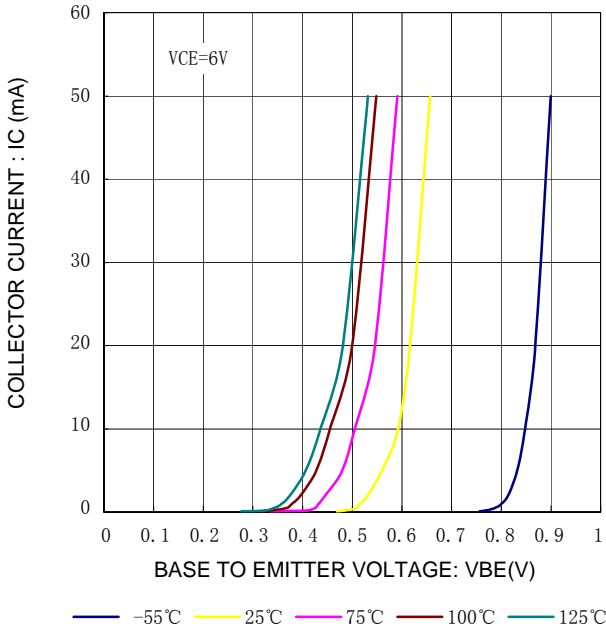

Fig.1 GROUNDED EMITTER PROPAGATION CHARACTERISTICS

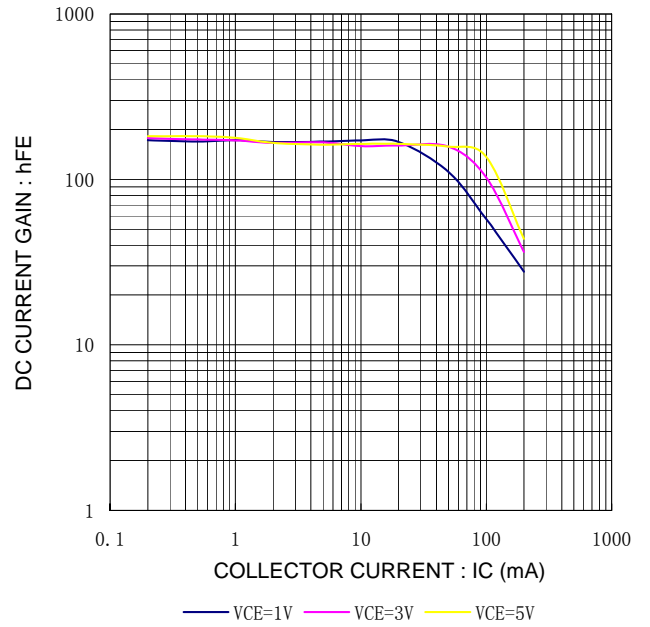

Fig.2 DC CURRENT GAIN VS.COLLECTOR CURRENT(1)

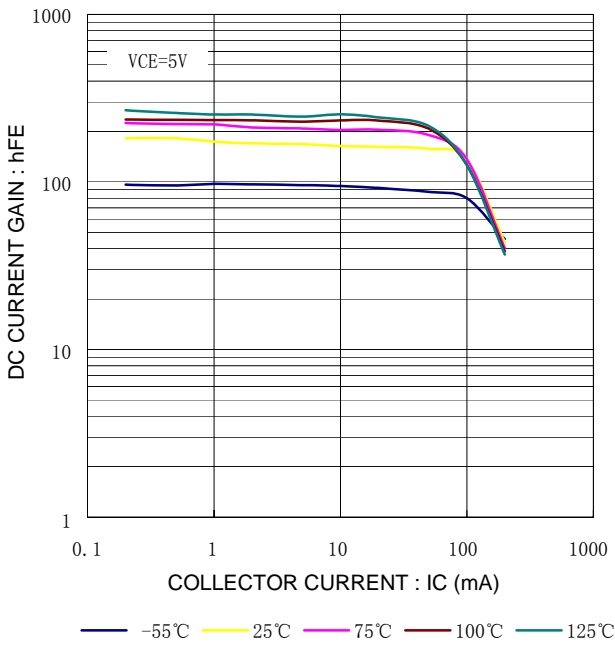

Fig.3 DC CURRENT GAIN VS.COLLECTOR CURRENT(2)

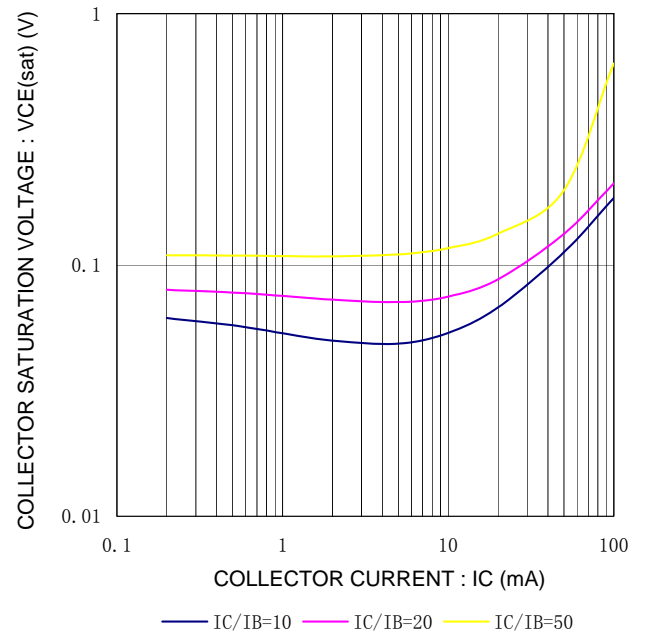

Fig.4 COLLECTOR-EMITTER SATURATION VOLTAGE VS.COLLECTOR CURRENT



ELECTRICAL CHARACTERISTIC CURVES
(Ta = 25°C)

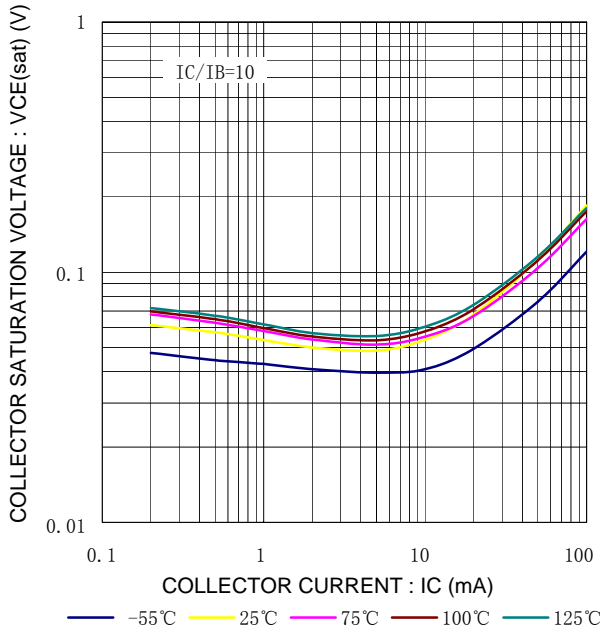

Fig.5 COLLECTOR-EMITTER SATURATION VOLTAGE VS.COLLECTOR CURRENT(1)

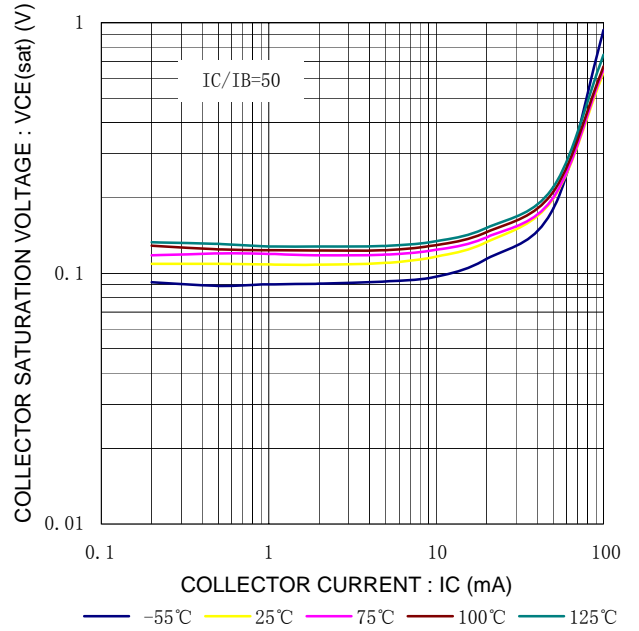

Fig.6 COLLECTOR-EMITTER SATURATION VOLTAGE VS.COLLECTOR CURRENT(2)

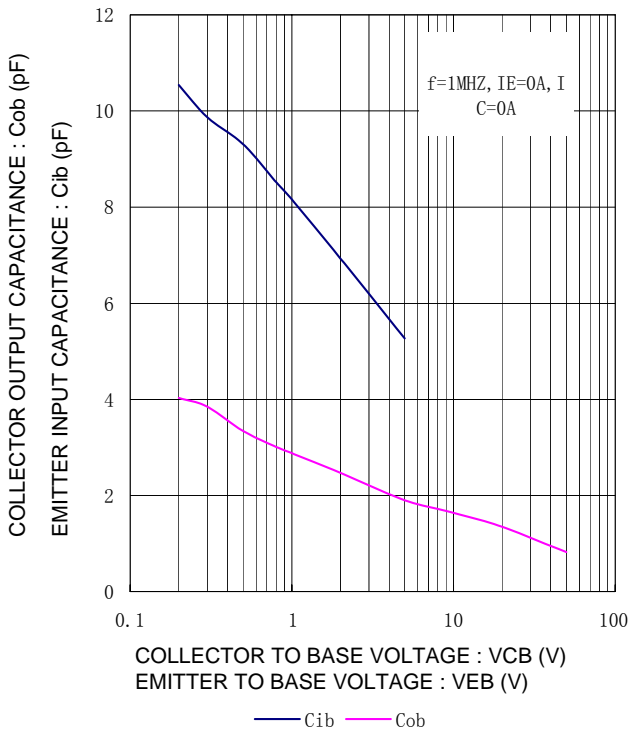

Fig.7 COLLECTOR OUTPUT CAPACITANCE VS. COLLECTOR-BASE VOLTAGE
EMITTER INPUT CAPACITANCE VS. EMITTER-BASE VOLTAGE

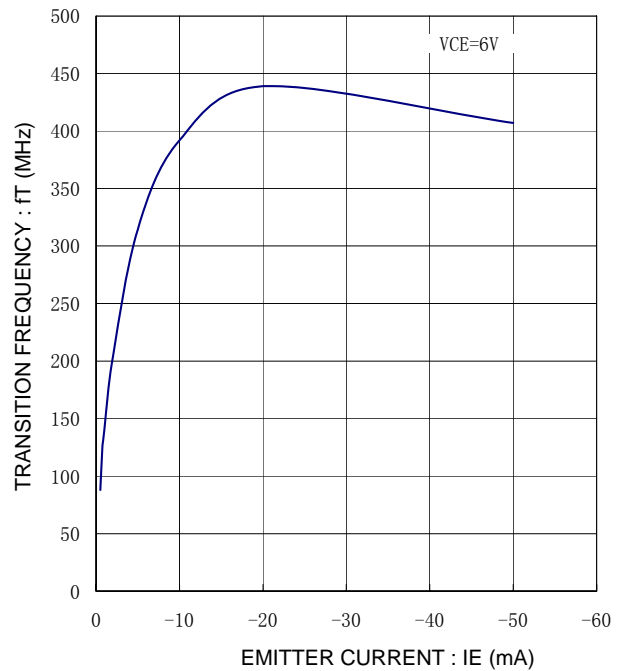
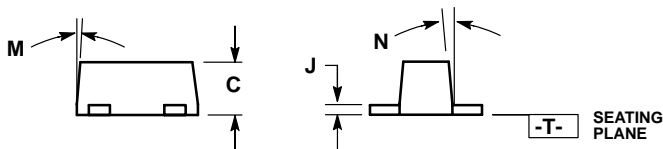
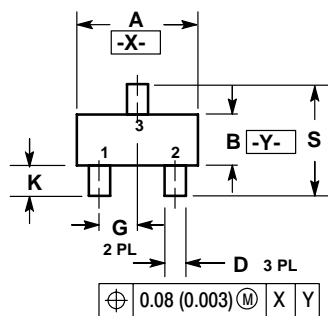

Fig.8 GAIN BANDWIDTH PRODUCT VS. EMITTER CURRENT



SOT-523



NOTES:

1. DIMENSIONING AND TOLERANCING PER ANSI Y14.5M, 1982.
2. CONTROLLING DIMENSION: MILLIMETERS
3. MAXIMUM LEAD THICKNESS INCLUDES LEAD FINISH THICKNESS. MINIMUM LEAD THICKNESS IS THE MINIMUM THICKNESS OF BASE MATERIAL.
4. 463C-01 OBSOLETE, NEW STANDARD 463C-02.

DIM	MILLIMETERS			INCHES		
	MIN	NOM	MAX	MIN	NOM	MAX
A	1.50	1.60	1.70	0.059	0.063	0.067
B	0.75	0.85	0.95	0.030	0.034	0.040
C	0.60	0.70	0.80	0.024	0.028	0.031
D	0.23	0.28	0.33	0.009	0.011	0.013
G	0.50 BSC			0.020 BSC		
H	0.53 REF			0.021 REF		
J	0.10	0.15	0.20	0.004	0.006	0.008
K	0.30	0.40	0.50	0.012	0.016	0.020
L	1.10 REF			0.043 REF		
M	---	---	10 °	---	---	10 °
N	---	---	10 °	---	---	10 °
S	1.50	1.60	1.70	0.059	0.063	0.067

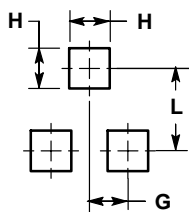

RECOMMENDED PATTERN OF SOLDER PADS

